

NOTES:

- A. CABINET WEIGHT 31.0 LBS [14.09 KG]
- B. SHIPPING WEIGHT 37.0 LBS [16.81 KG]

		REVISIONS			
ZONE	REV.	DESCRIPTION	DATE	APPROVED	

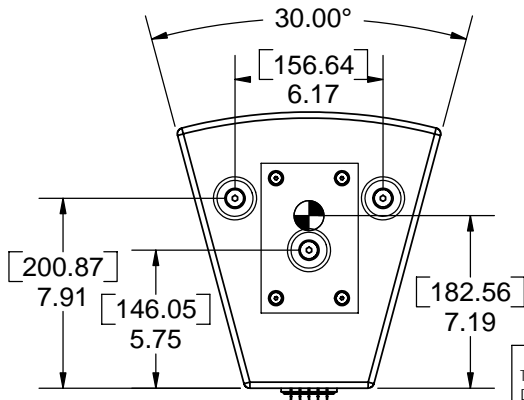
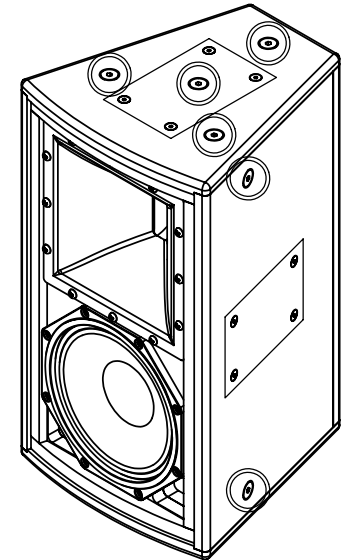
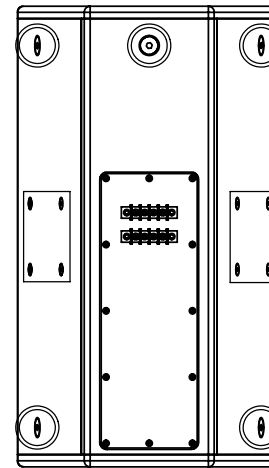
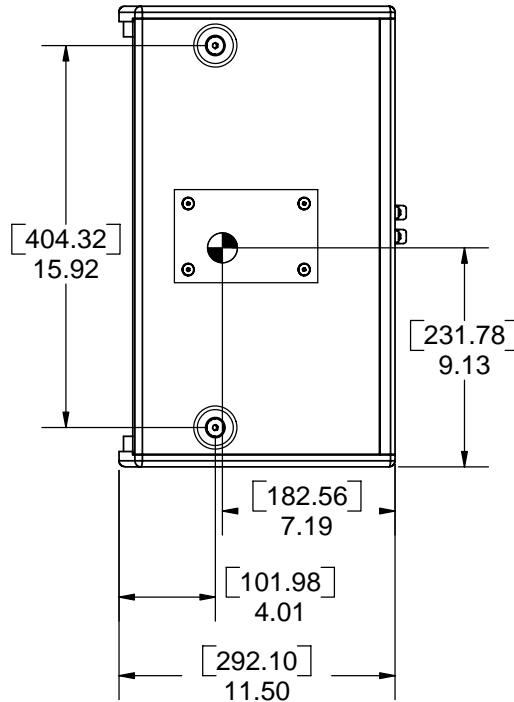
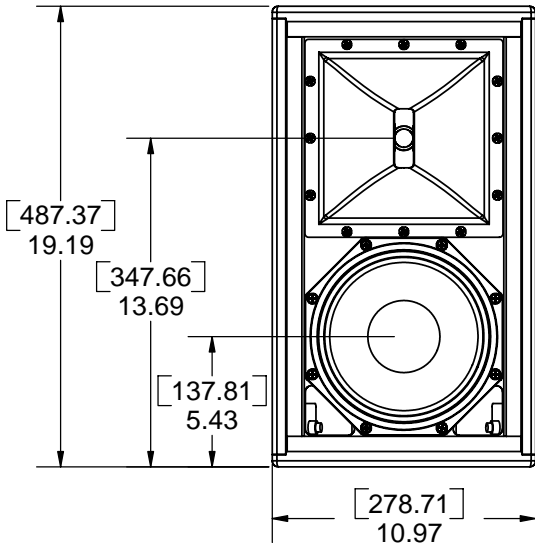
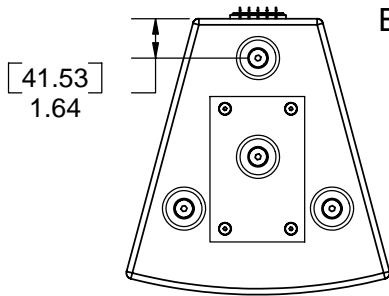

PROPRIETARY AND CONFIDENTIAL
 THE INFORMATION CONTAINED IN THIS DRAWING IS THE SOLE PROPERTY OF McCauley Sound Inc. ANY REPRODUCTION OF SAID PRODUCT, IN PART OR AS A WHOLE WITHOUT THE WRITTEN PERMISSION OF McCauley Sound Inc. IS PROHIBITED.

PRIMARY UNITS US CUSTOMARY
 SECONDARY UNITS SI
 TOLERANCES:
 LINEAR: ±0.125" UCS, ±3.17E-3 m SI
 ANGULAR: ±1°
 BEND ±5°
 WEIGHT: ±0.1lb UCS, BY MASS ±0.045kg SI
 STANDARD FINISH
Black ProCoat
 OPTIONAL FINISHES
White
 ORDERING OPTIONS
 P, PW, W

	NAME	DATE
DRAWN	RM	071006
CHECKED	RM	071006

Denotes Center of gravity
 5/18 X 18 T-NUT FOR 60 SERIES OMNI MOUNT
 3/8 X 18 FLY POINT
 DRAWING NOT TO SCALE

McCauley Sound Inc.
 16607 Meridian Ave E
 Puyallup, WA 98375
 (ph 253-848-0363) (fax 253-841-3050)
www.mccauleysound.com
www.linearray.com

SIZE	ID1.108-96	REV.	1
------	------------	------	---